

Data Sheet

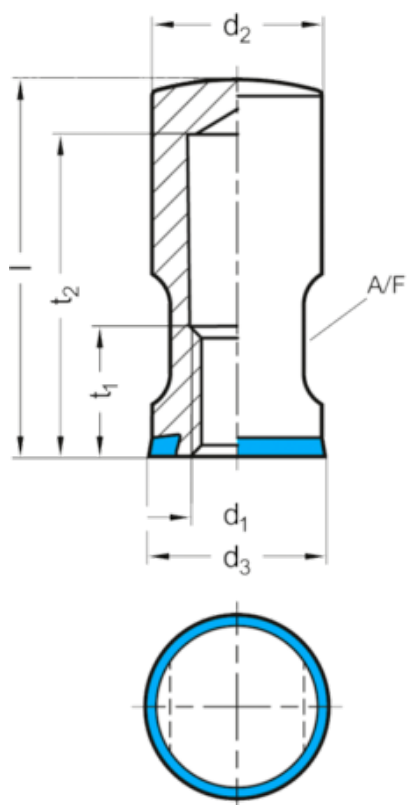

Article number: 20201M1662H
Description: GN 20.1-M16-62-H
Stainless Steel-Cover sleeves
Note: Hygienic Design

Measures



Application example

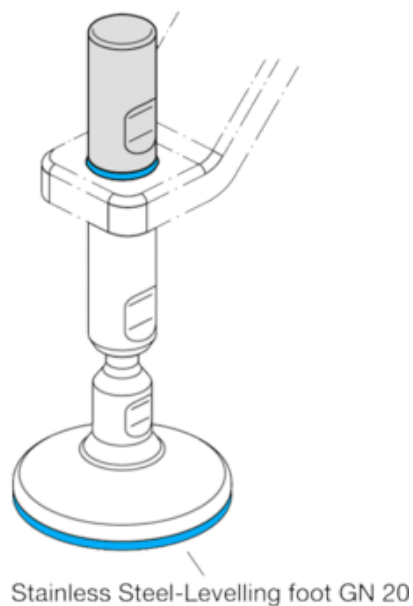

A/F	= 22
d1	= M 16
d2	= 28
d3	= 28.8
l	= 62
t1	= 20.5
t2	= 55
Weight in (g)	= 200